

FEATURES

- (1) 12.1 SVGA for FA and LCD monitor use
- (2) High Brightness 250 cd/m² with twin CCFL Backlight
- (3) Long life CCFLs (Average life time : 25000 hours)

TENTATIVE

MECHANICAL SPECIFICATIONS

Item	Specifications
Dimensional Outline (typ.)	290.0 (W) x 220.0 (H) x 15.0max (D) mm
Number of Pixels	800 (W) x 600 (H) pixels
Active Area	246.0 (W) x 184.5 (H) mm
Pixel Pitch	0.3075 (W) x 0.3075 (H)
Weight (approximately)	840g
Backlight	Twin CCFLs, Sidelight type

ABSOLUTE MAXIMUM RATINGS

Item	Min.	Max.	Unit	
Supply Voltage	(V _{DD})	-0.3	7.0	V
	(V _{FL})	0	2.0	kV(rms)
FL Driving Frequency (f _{FL})	0	100	KHz	
Input Signal Voltage (V _{IN})	-0.3	V _{DD} +0.3	V	
Operating Ambient Temperature ^{*1}	0	50	°C	
Operating Temperature for Panel ^{*2}	0	60	°C	
Storage Temperature	-20	60	°C	
Storage Humidity (Max. wet bulb temperature = 39°C)	10	90	%(RH)	

*1: Wet bulb temperature should be 39°C Max., and no condensation of water.

*2: The surface temperature caused by self heat radiation of cell itself is specified on this item.

ELECTRICAL SPECIFICATION (T_a=25°C)

Item	Min.	Typ.	Max.	Unit	Remarks	
Supply Voltage	(V _{DD})	4.75	5.0	5.25	V	
	(V _{FL})	580	630	680	V(rms)	I _{FL} =6.0 mA(rms)
FL Start Voltage	1400	---	1900	V(rms)	T _a =0°C	
High Level Input Voltage (V _{IH})	0.8V _{DD}	---	V _{DD}			
Low Level Input Voltage (V _{IL})	0	---	0.2V _{DD}	V		
Current Consumption	(I _{DD}) ^{*1}	---	170	270	mA	
	(I _{FL}) ^{*2}	3.0	6.0	6.5	mA(rms)	
Power Consumption ^{*1 *2}	---	8.4	---	W	I _{FL} =6.0mA(rms)	

*1: 8 color bars pattern

*2: Except the efficiency of FL inverter

OPTICAL SPECIFICATION (T_a=25°C)

Item	Min.	Typ.	Max.	Unit	Remarks
Contrast Ratio (CR)	100	250	---	---	
Response Time	(t _{ON})	---	---	50	ms
	(t _{OFF})	---	---	50	ms
Luminance (L)	200	250	---	cd/m ²	I _{FL} =6.0mA(rms)

*The information contained herein is presented only as a guide for the applications of our products. No responsibility is assumed by Toshiba or other rights of the third parties which may result from its use. No license is granted by implication or otherwise under any patent or patent rights of Toshiba or others.

*The information contained herein may be changed without prior notice. It is therefore advisable to contact Toshiba before proceeding with the design of equipment incorporating this product.

DIMENSIONAL OUTLINE

TENTATIVE

Unit : mm

Standard tolerance : 0.5

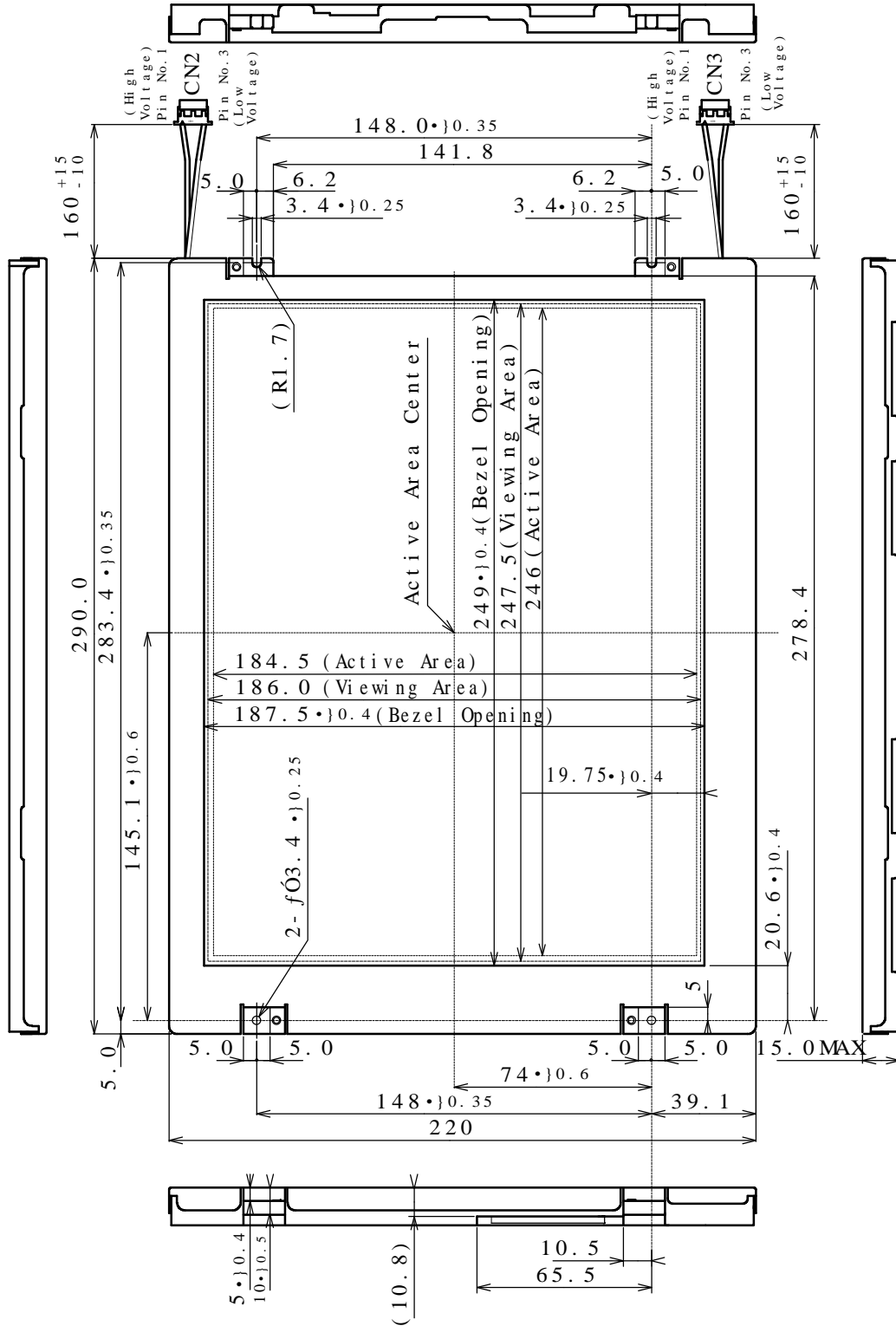

DIMENSIONAL OUTLINE

TENTATIVE

Unit : mm

Standard tolerance : 0.5

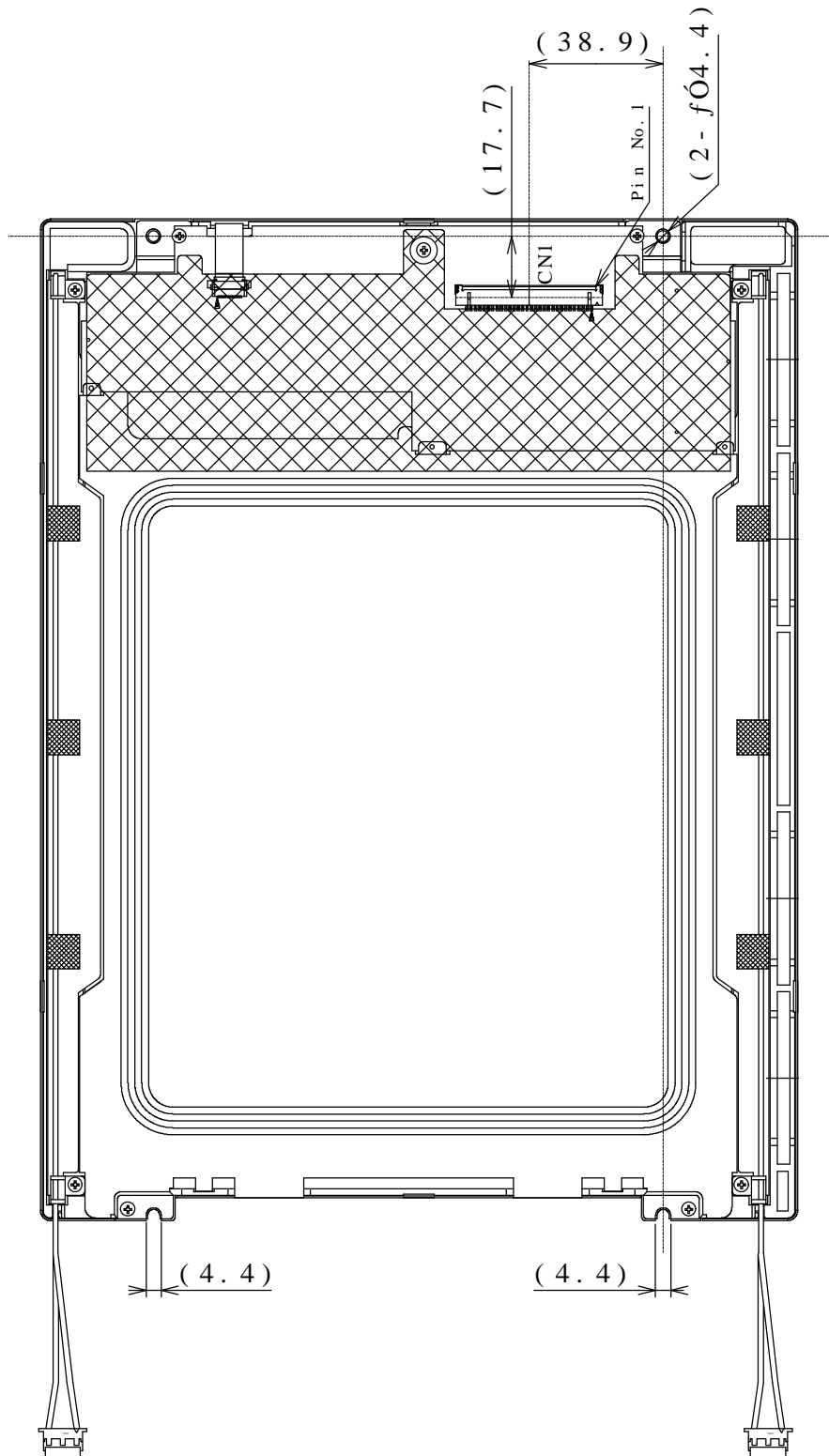

BLOCK DIAGRAM

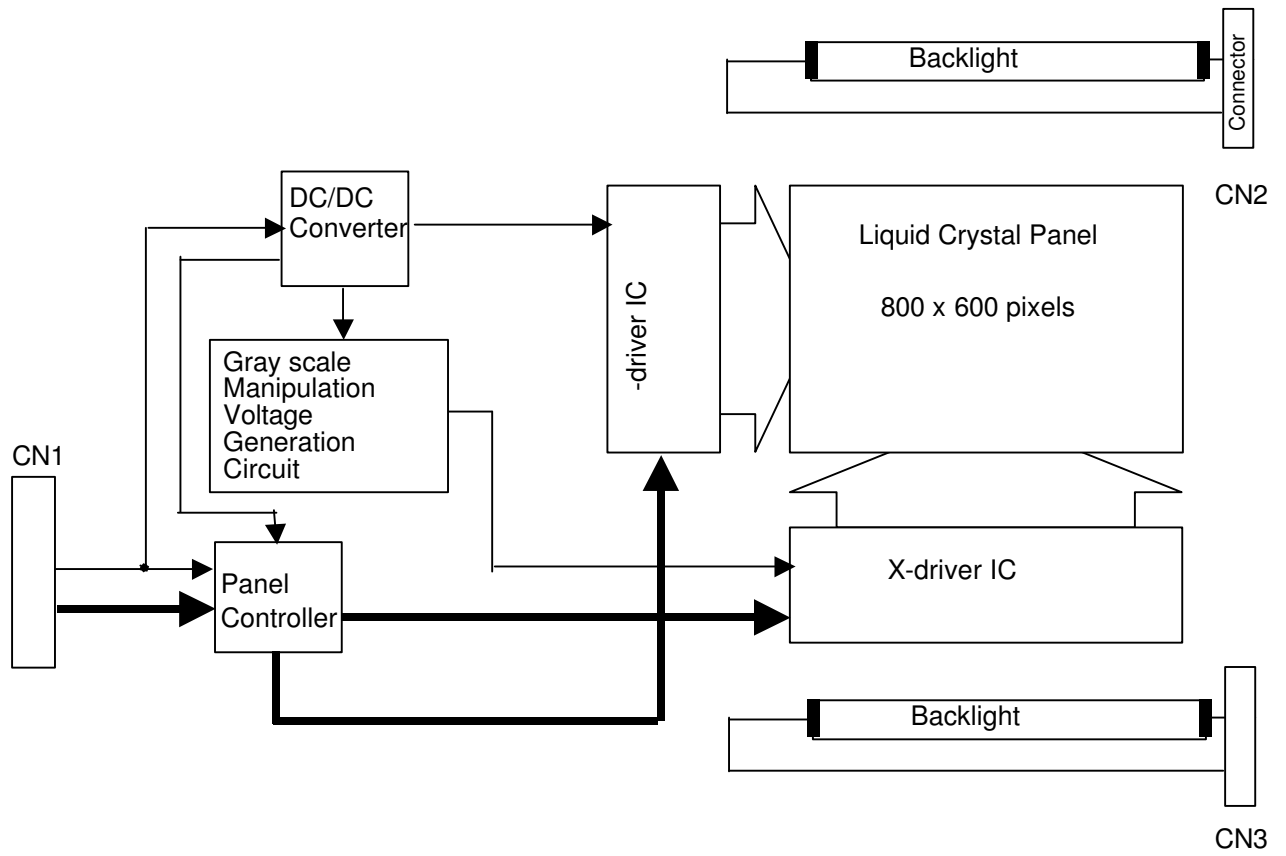

(1) Vertical Timing

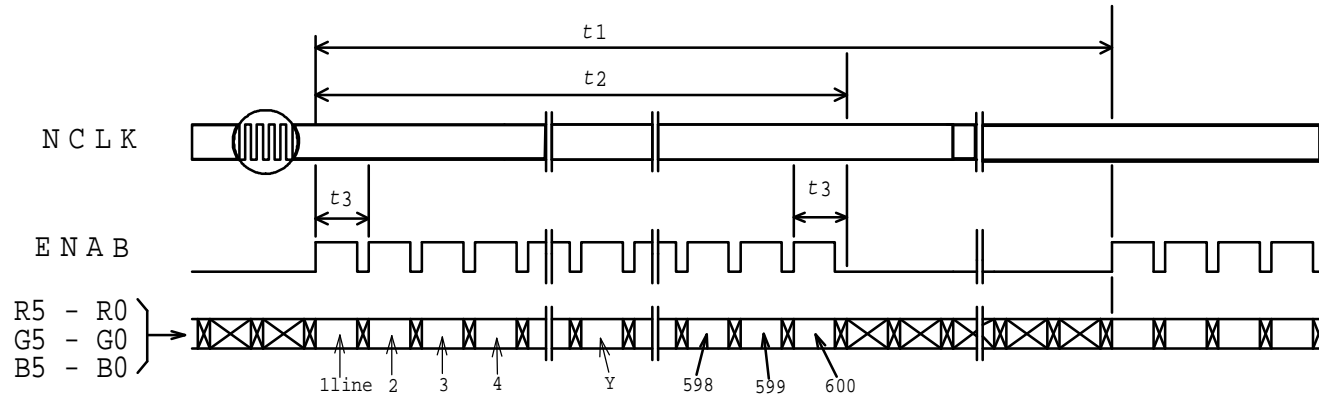

(2) Horizontal Timing

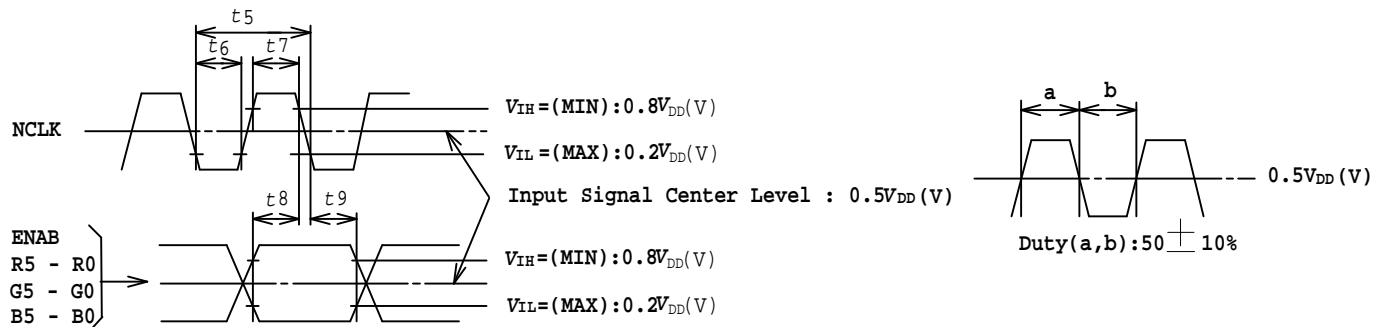
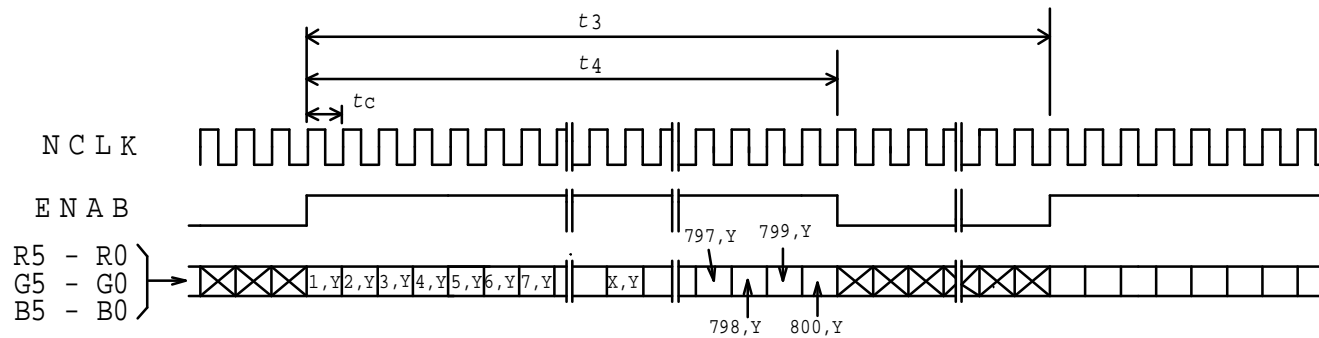

(5/9)

2000-03-14 (Ver.3.0)

TIMING SPECIFICATION 1) 2) 3) 4) 5) 6) 7) 8) 9)

Item	Symbol	Min.	Typ.	Max.	Unit
Frame Period	t_1	604 x t_3 -	625 x t_3 17.78	628 x t_3 17.86	--- ms
Vertical Display Term	t_2	600 x t_3	600 x t_3	600 x t_3	---
One Line Scanning Time	t_3	844 x t_c 26.4	1024 x t_c 28.44	1056 x t_c ---	--- μ s
Horizontal Display Term	t_4	800 x t_c	800 x t_c	800 x t_c	---
Clock Period	t_c	25.0	27.78	---	ns
Clock "L" Time	t_6	5.0	---	---	ns
Clock "H" Time	t_7	8.0	---	---	ns
Set Up Time	t_8	3.0	---	---	ns
Hold Time	t_9	7.0	---	---	ns

Note 1) When ENAB is fixed to "H" level or "L" level after NCLK input, the panel is displayed as black. However, it may be occurred a flicker on the display.

Note 2) Don't fix NCLK to "H" or "L" level while the VDD(+5V) is supplied.
If NCLK is fixed to "H" or "L" level, the normal operating signal isn't supplied to LCD panel.
This condition results the degradation of the LCD panel display quality.

Note 3) Display area address is as follows.

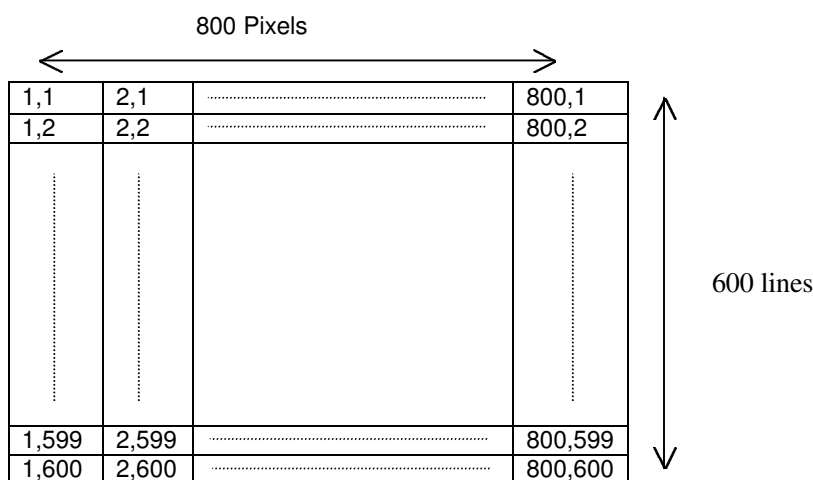

Note 4) Please adjust LCD operating signal timing and FL driving frequency, to optimize the display quality.
There is a possibility that flicker is observed by the interference of LCD operating signal timing and FL driving condition (especially driving frequency).

Note 5) Do not fluctuate t_1 , t_2 and t_3 , otherwise the panel is displayed as black.

Note 6) 1. NCLK count of each Horizontal Scanning Time should be always the same.
2. V-Blanking period should be "n" x "Horizontal Scanning Time". (n : integer)
3. Frame period should be always the same.

CONNECTOR PIN ASSIGNMENT FOR INTERFACE

CN1 INPUT SIGNAL

Connector : DF14A-30P-1.25H / HIROSE ELECTRIC CO.,LTD

Mating Connector : DF14-30S-1.25C, Contact Pin : DF14-2628SCF, DF14-3032SCF

Terminal No.	Symbol	Function
1	GND	
2	NCLK	SAMPLING CLOCK
3	NC ¹⁾	
4	NC ¹⁾	
5	GND	
6	R0 ²⁾	RED DISPLAY DATA (LSB)
7	R1 ²⁾	RED DISPLAY DATA
8	R2 ²⁾	RED DISPLAY DATA
9	R3 ²⁾	RED DISPLAY DATA
10	R4 ²⁾	RED DISPLAY DATA
11	R5 ²⁾	RED DISPLAY DATA (MSB)
12	GND	
13	G0 ²⁾	GREEN DISPLAY DATA (LSB)
14	G1 ²⁾	GREEN DISPLAY DATA
15	G2 ²⁾	GREEN DISPLAY DATA
16	G3 ²⁾	GREEN DISPLAY DATA
17	G4 ²⁾	GREEN DISPLAY DATA
18	G5 ²⁾	GREEN DISPLAY DATA (MSB)
19	GND	
20	B0 ²⁾	BLUE DISPLAY DATA (LSB)
21	B1 ²⁾	BLUE DISPLAY DATA
22	B2 ²⁾	BLUE DISPLAY DATA
23	B3 ²⁾	BLUE DISPLAY DATA
24	B4 ²⁾	BLUE DISPLAY DATA
25	B5 ²⁾	BLUE DISPLAY DATA (MSB)
26	ENAB	COMPOUND SYNCHRONIZATION SIGNAL
27	GND	
28	VDD	+5.0V POWER SUPPLY
29	VDD	+5.0V POWER SUPPLY
30	GND	

CN2, CN3 CCFL POWER SOURCE

Connector : BHR-03VS-1 / JAPAN SOLDERLESS TERMINAL MFG CO., LTD.

Mating Connector : SM02(8.0)B-BHS-1 / JAPAN SOLDERLESS TERMINAL MFG CO., LTD.

Terminal No.	Symbol	Function
1	V _{FLH}	CCFL Power Supply (high voltage)
2	NC ¹⁾	Non Connection (open)
3	V _{FL}	CCFL Power Supply (low voltage)

Note 1) NC terminal should be open.

Note 2) See next page.

256k (k=1024) COLORS COMBINATION TABLE

	Display	R5 R4 R3 R2 R1 R0	G5 G4 G3 G2 G1 G0	B5 B4 B3 B2 B1 B0	Gray Scale Level
Basic Color	Black	L L L L L L	L L L L L L	L L L L L L	-
	Blue	L L L L L L	L L L L L L	H H H H H H	-
	Green	L L L L L L	H H H H H H	L L L L L L	-
	Light Blue	L L L L L L	H H H H H H	H H H H H H	-
	Red	H H H H H H	L L L L L L	L L L L L L	-
	Purple	H H H H H H	L L L L L L	H H H H H H	-
	Yellow	H H H H H H	H H H H H H	L L L L L L	-
	White	H H H H H H	H H H H H H	H H H H H H	-
Gray Scale of Red	Black	L L L L L L	L L L L L L	L L L L L L	L 0
	Dark ↑ ↓ Light	L L L L L H	L L L L L L	L L L L L L	L 1
		L L L L H L	L L L L L L	L L L L L L	L 2
		:	:	:	L3...
		:	:	:	L60
		H H H H L H	L L L L L L	L L L L L L	L61
	H H H H H L	L L L L L L	L L L L L L	L62	
Red	H H H H H H	L L L L L L	L L L L L L	Red L63	
Gray Scale of Green	Black	L L L L L L	L L L L L L	L L L L L L	L 0
	Dark ↑ ↓ Light	L L L L L L	L L L L L H	L L L L L L	L 1
		L L L L L L	L L L L H L	L L L L L L	L 2
		:	:	:	L3...
		:	:	:	L60
		L L L L L L	H H H H L H	L L L L L L	L61
	L L L L L L	H H H H H L	L L L L L L	L62	
Green	L L L L L L	H H H H H H	L L L L L L	Green L63	
Gray Scale of Blue	Black	L L L L L L	L L L L L L	L L L L L L	L 0
	Dark ↑ ↓ Light	L L L L L L	L L L L L L	L L L L L H	L 1
		L L L L L L	L L L L L L	L L L L H L	L 2
		:	:	:	L3...
		:	:	:	L60
		L L L L L L	L L L L L L	H H H H L H	L61
	L L L L L L	L L L L L L	H H H H H L	L62	
Blue	L L L L L L	L L L L L L	H H H H H H	Blue L63	
Gray Scale of White & Black	Black	L L L L L L	L L L L L L	L L L L L L	L 0
	Dark ↑ ↓ Light	L L L L L H	L L L L L H	L L L L L H	L 1
		L L L L H L	L L L L H L	L L L L H L	L 2
		:	:	:	L3...
		:	:	:	L60
		H H H H L H	H H H H L H	H H H H L H	L61
	H H H H H L	H H H H H L	H H H H H L	L62	
White	H H H H H H	H H H H H H	H H H H H H	White L63	

**FOR SAFETY**

LCD module is generally designed with precise parts to achieve light weighted thin mechanical dimensions. In using our Modules, make certain that you fully understand and put into practice the warnings and safety precautions detailed in Engineering Information No.EE-N001,"CAUTIONS AND INSTRUCTIONS FOR TOSHIBA LCD MODULES". Refer to individual specifications and TECHNICAL DATA sheets (hereinafter called "TD") for more detailed technical information.

1) SPECIAL PURPOSES

A) Toshiba's Standard LCD Modules have not been customized for operation in extreme environments or for use in applications where performance failures could be life-threatening or otherwise catastrophic.

B) Since Toshiba's Standard LCD Modules have not been designed for operation in extreme environments, they must never be used in devices that will be exposed to abnormally high levels of vibration or shock which exceed Toshiba's published specification limits.

C) In addition, since Toshiba Standard LCD Modules have not been designed for use in applications where performance failures could be life-threatening or catastrophic, they must never be installed in aircraft navigation control systems (such as, but not limited to Traffic Collision Avoidance System and Air Traffic Indicator), in military defense or weapons systems, in critical industrial process-control systems (e.g., those involved in the production of nuclear energy), or in critical medical device or patient life-support systems.

2) DISASSEMBLING OR MODIFICATION

DO NOT DISASSEMBLE OR MODIFY the module. It may damage sensitive parts inside LCD module, and may cause scratches or dust on the display.

Toshiba does not warrant the module, if customer disassembled or modified it.

3) BREAKAGE OF LCD PANEL

DO NOT INGEST liquid crystal material, DO NOT INHALE this material, and DO NOT CONTACT the material with skin, if LCD panel is broken and liquid crystal material spills out.

If liquid crystal material comes into mouth or eyes, rinse mouth or eyes out with water immediately.

If this material contact with skin or cloths, wash it off immediately with alcohol and rinse thoroughly with water.

4) GLASS OF LCD PANEL

BE CAREFUL WITH CHIPS OF GLASS that may cause injuring fingers or skin, when the glass is broken.

5) ELECTRIC SHOCK

DISCONNECT POWER SUPPLY before handling LCD module.

DO NOT TOUCH the parts inside LCD module and the fluorescent lamp's connector or cables in order to prevent electric shock, because high voltage is supplied to these parts from the inverter unit while power supply is turned on.

6) ABSOLUTE MAXIMUM RATINGS AND POWER PROTECTION CIRCUIT

DO NOT EXCEED the absolute maximum rating values under the worst probable conditions caused by the supply voltage variation, input voltage variation, variation in parts' constants, environmental temperature, etc., otherwise LCD module may be damaged.

Employ protection circuit for power supply, whenever the specification or TD specifies it.

Suitable protection circuit should be applied for each system design.

7) DISPOSAL

When dispose LCD module, obey to the applicable environmental regulations.